

Bandpass Filter 232751B



1. Features

- IF bandpass filter
- Low-Loss Filter
- Single-ended operation
- Ceramic Surface Mount Device(SMD) Package
- Maximum Storage Temperature Range : -40℃ ~ 85℃
- Electrostatics Sensitive Device (ESD)

2. Package Dimension

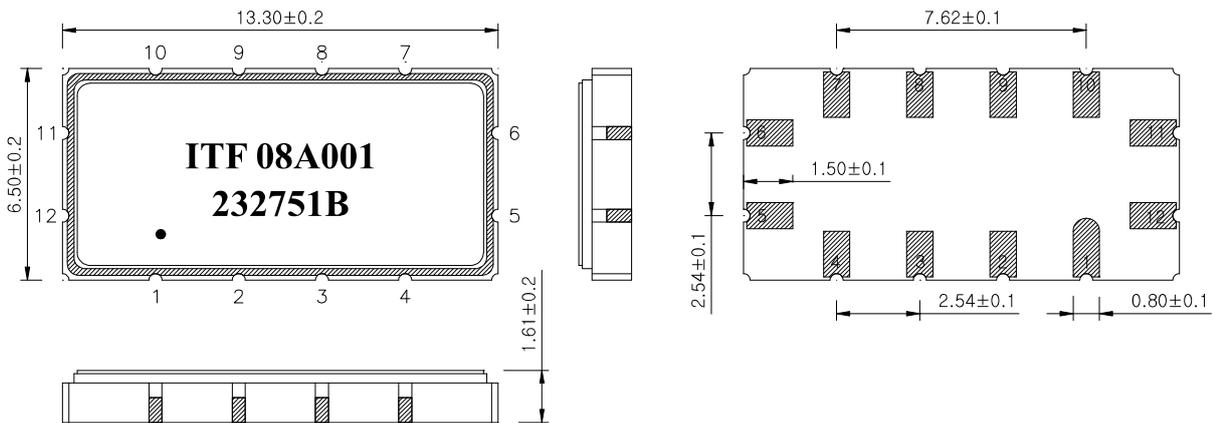

Package : S1365

Dimensions shown are nominal in millimeters

Body : Al₂O₃

Lid : Kovar, Ni Plated

Termination : Au plating 0.3 ~ 1.0um, over a 1.27 ~ 8.89um Ni Plating

Pin Configuration	
11	Input
5	Output
6, 12	Ground
Other	Case ground

	ITF Co., Ltd. 102-901, Bucheon Technopark 364, Samjeong-Dong, Ojeong-Gu, Bucheon-City, Gyeonggi-Do, Korea 421-809	Part No.	232751B	
		Rev. Date	2008-09-04	
		Rev.	NJ8014-CS01	1/5

Bandpass Filter 232751B



3. Specifications

F_o = 75.0 MHz

Terminating source impedance : 50Ω and matching network

Terminating load impedance : 50Ω and matching network

Room temperature : +25°C		Minimum	Typical	Maximum
Center Frequency (F _c)	MHz	-	75.0	-
Insertion Loss	dB	-	18.0	21.0
1dB Bandwidth	MHz	26.0	26.56	-
3dB Bandwidth	MHz	-	27.36	-
30dB Bandwidth	MHz	-	30.26	30.8
40dB Bandwidth	MHz	-	30.85	31.5
Amplitude Ripple (F _o +/- 12.5 MHz)	dB	-	0.4	0.8
Group Delay Variation (F _o +/- 12.5 MHz)	nsec	-	30	60
Absolute Delay	usec	-	1.09	1.2
Ultimate Rejection	dB	40	45	-
Temperature Coefficient of Frequency (TCF)	ppm/°C	-	- 86	-

Notes :

- 1) All specifications are based on the matching schematic shown below
- 2) All specifications are measured by Agilent Network analyzer and full 2 port calibration
- 3) Electrical margin has been built into the design to account for the variations due to temperature drift and manufacturing tolerances
- 4) All attenuation measurements are measured relative to insertion loss

 Integrated Technology Future	ITF Co., Ltd. 102-901, Bucheon Technopark 364, Samjeong-Dong, Ojeong-Gu, Bucheon-City, Gyeonggi-Do, Korea 421-809	Part No.	232751B	
		Rev. Date	2008-09-04	
		Rev.	NJ8014-CS01	2/5

Bandpass Filter 232751B



4. Matching Schematic

(Actual matching values may vary due to PCB layout and parasitics)

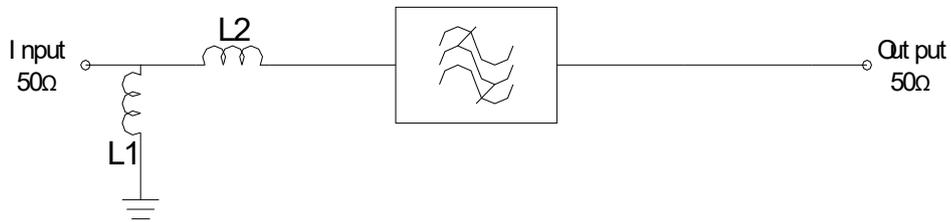

$L1 = 68 \text{ nH}$, $L2 = 3.9 \text{ nH}$

5. Marking Configuration

ITF¹⁾ 08A001²⁾

232751B³⁾

●⁴⁾

1) Manufacturer name

2) Lot Number

3) Part Number

4) Pad Number 1 Index

	ITF Co., Ltd. 102-901, Bucheon Technopark 364, Samjeong-Dong, Ojeong-Gu, Bucheon-City, Gyeonggi-Do, Korea 421-809	Part No.	232751B	
		Rev. Date	2008-09-04	
		Rev.	NJ8014-CS01	3/5

Bandpass Filter 232751B



6. Typical Performance (at +25°C)

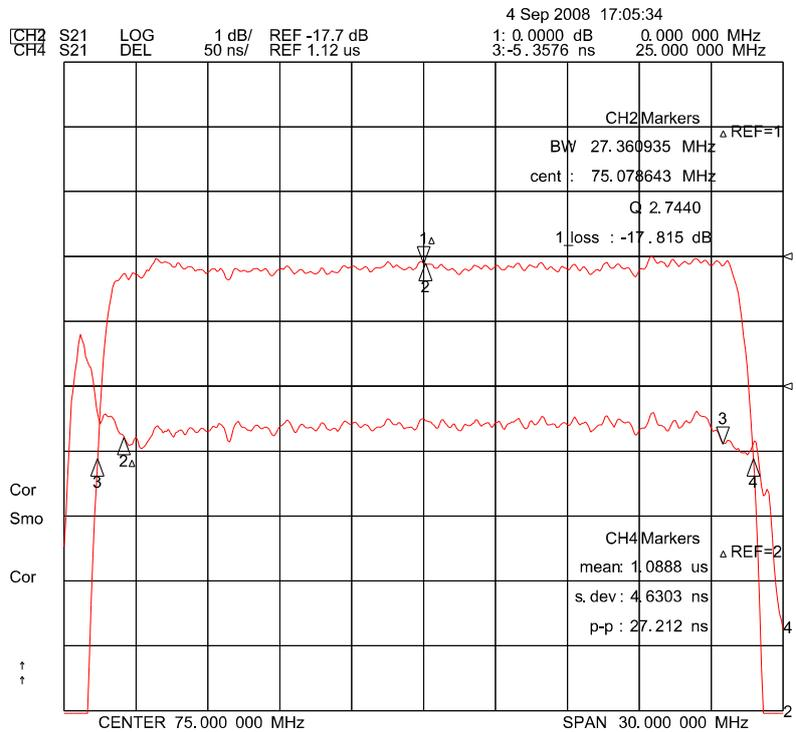
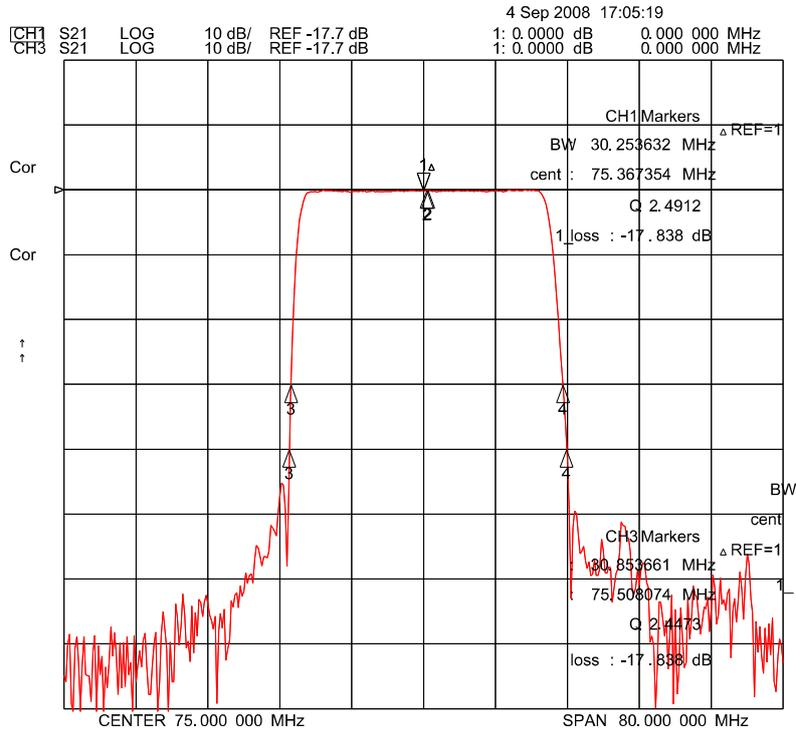

	ITF Co., Ltd. 102-901, Bucheon Technopark 364, Samjeong-Dong, Ojeong-Gu, Bucheon-City, Gyeonggi-Do, Korea 421-809	Part No.	232751B	
		Rev. Date	2008-09-04	
		Rev.	NJ8014-CS01	4/5

Bandpass Filter 232751B

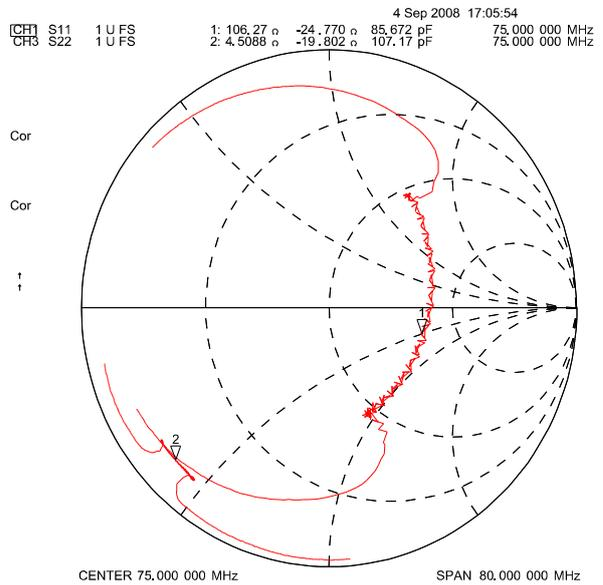
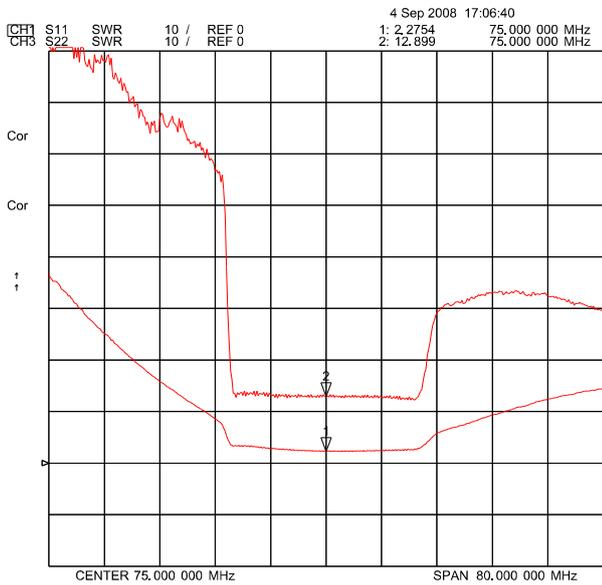
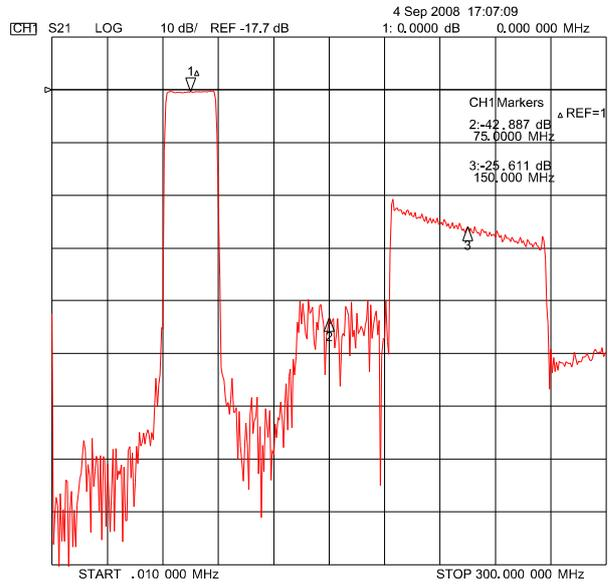
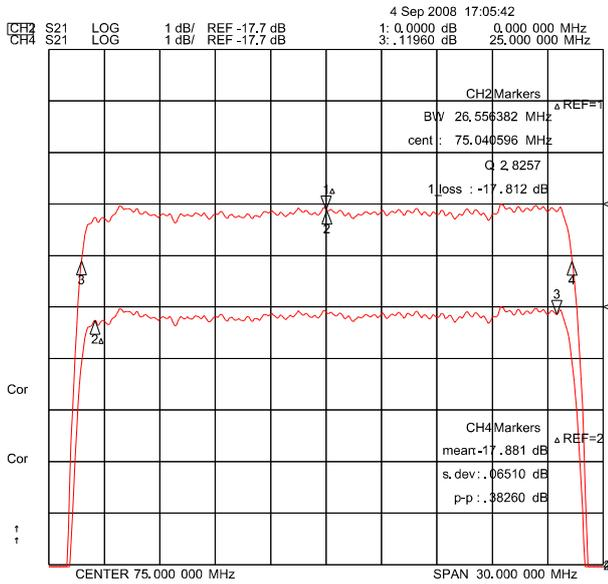

	ITF Co., Ltd. 102-901, Bucheon Technopark 364, Samjeong-Dong, Ojeong-Gu, Bucheon-City, Gyeonggi-Do, Korea 421-809	Part No.	232751B	
		Rev. Date	2008-09-04	
		Rev.	NJ8014-CS01	5/5